

Birdhouse: Draw the Isometric View

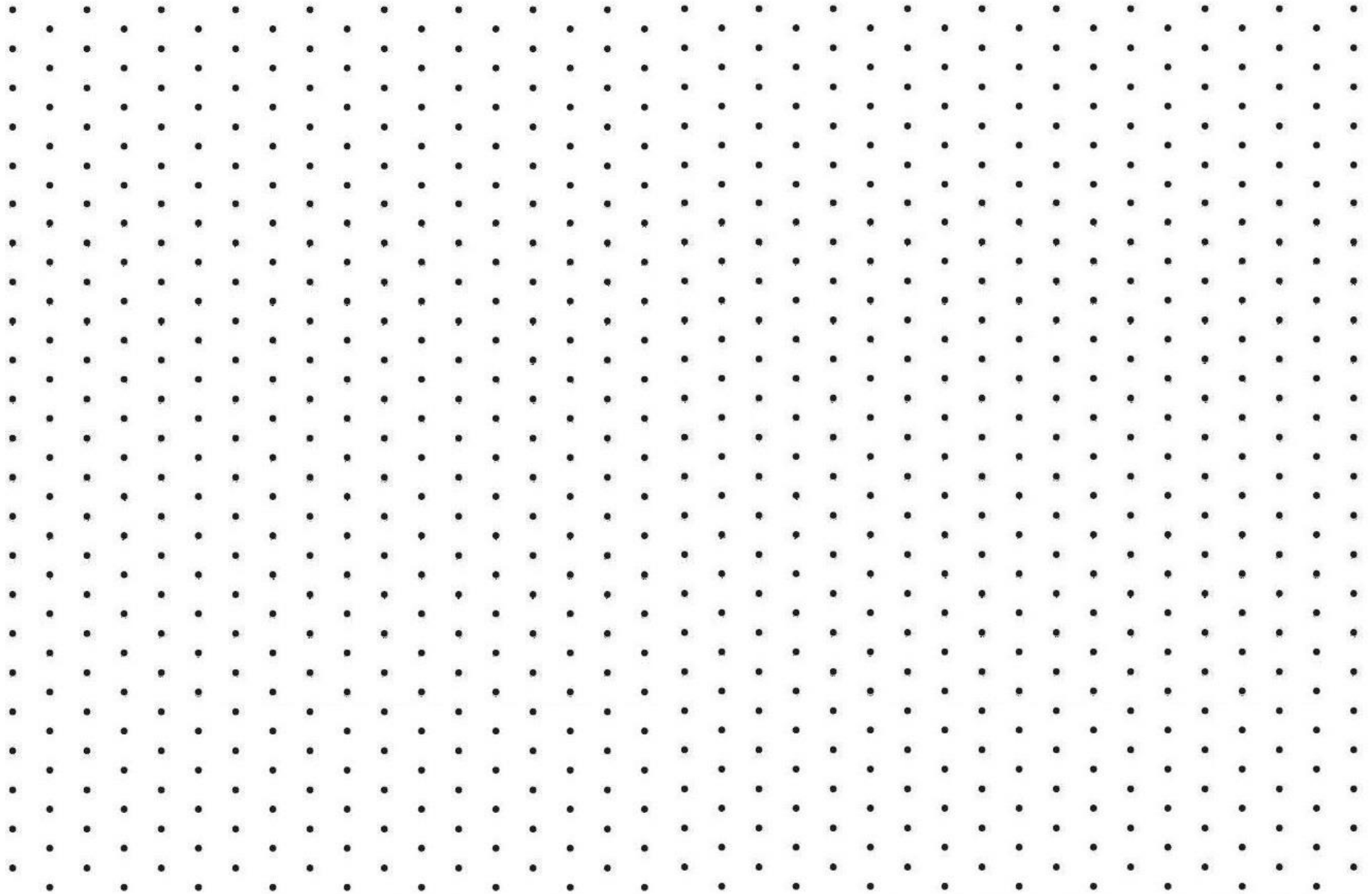

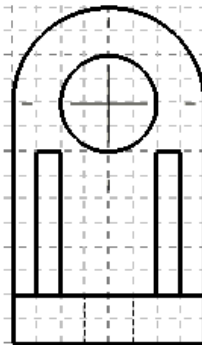

**Braced Bracket: Draw the Isometric View**

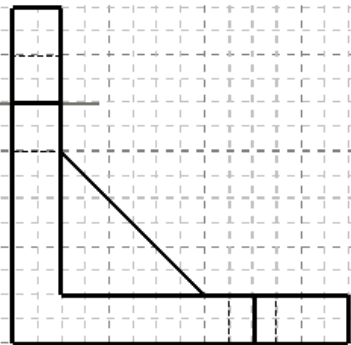
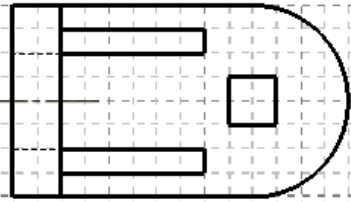
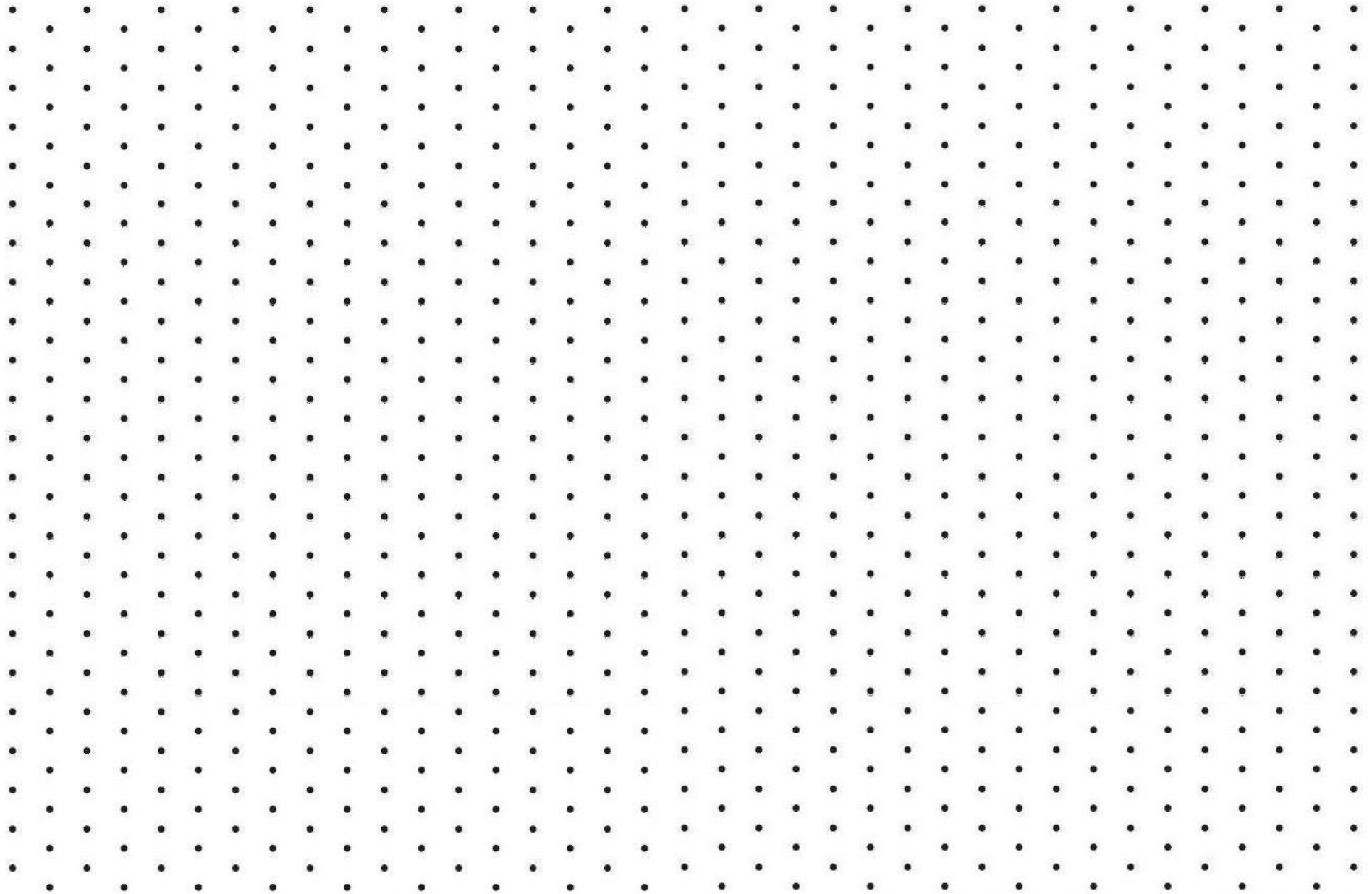

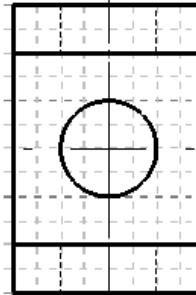
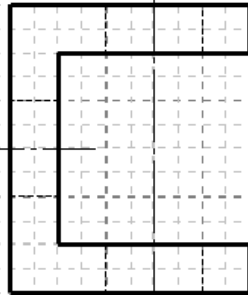
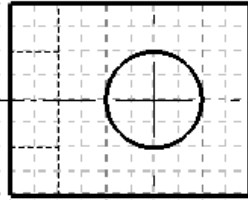

**C Bracket: Draw the Isometric View**

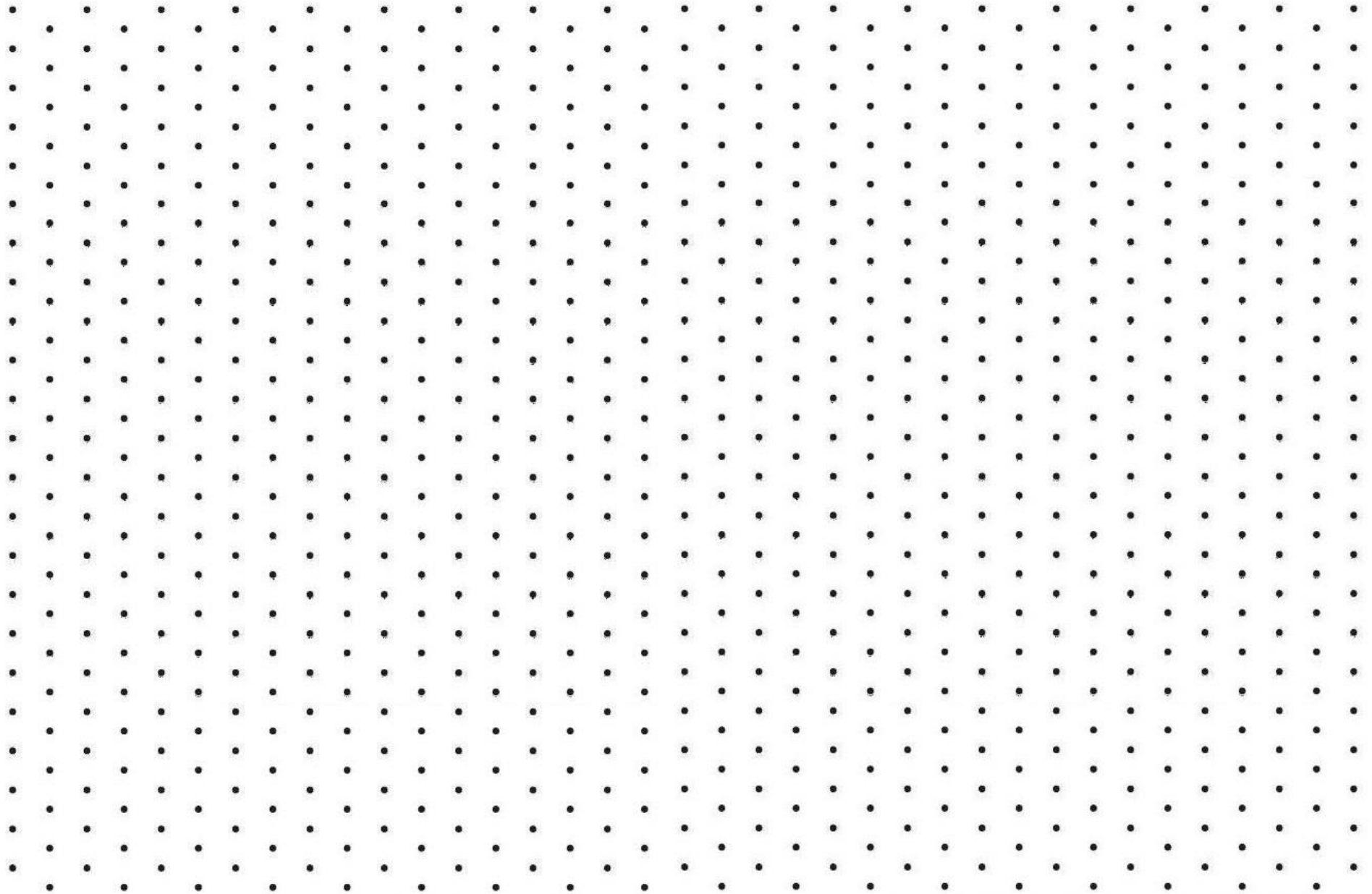

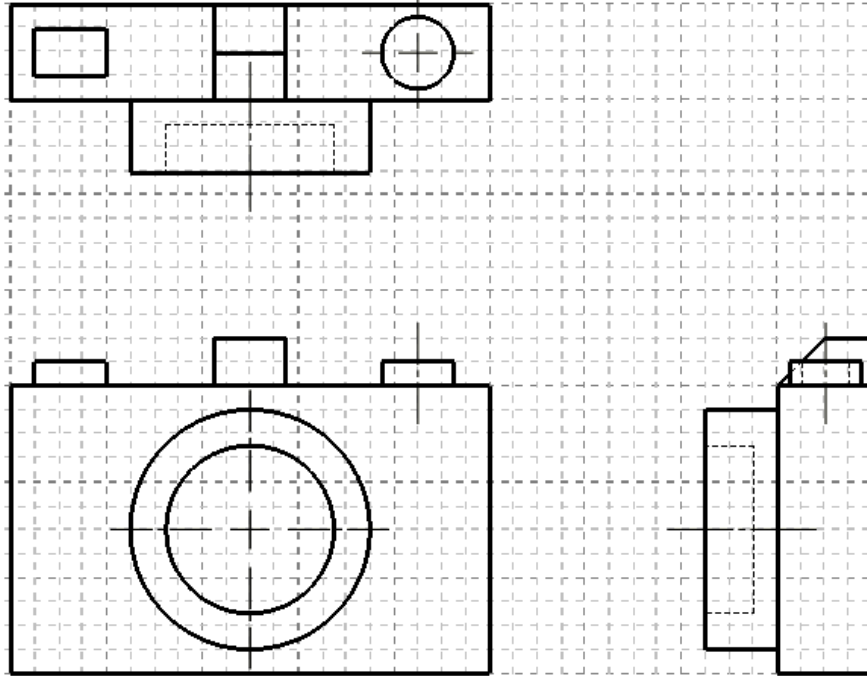

Camera: Draw the Isometric View

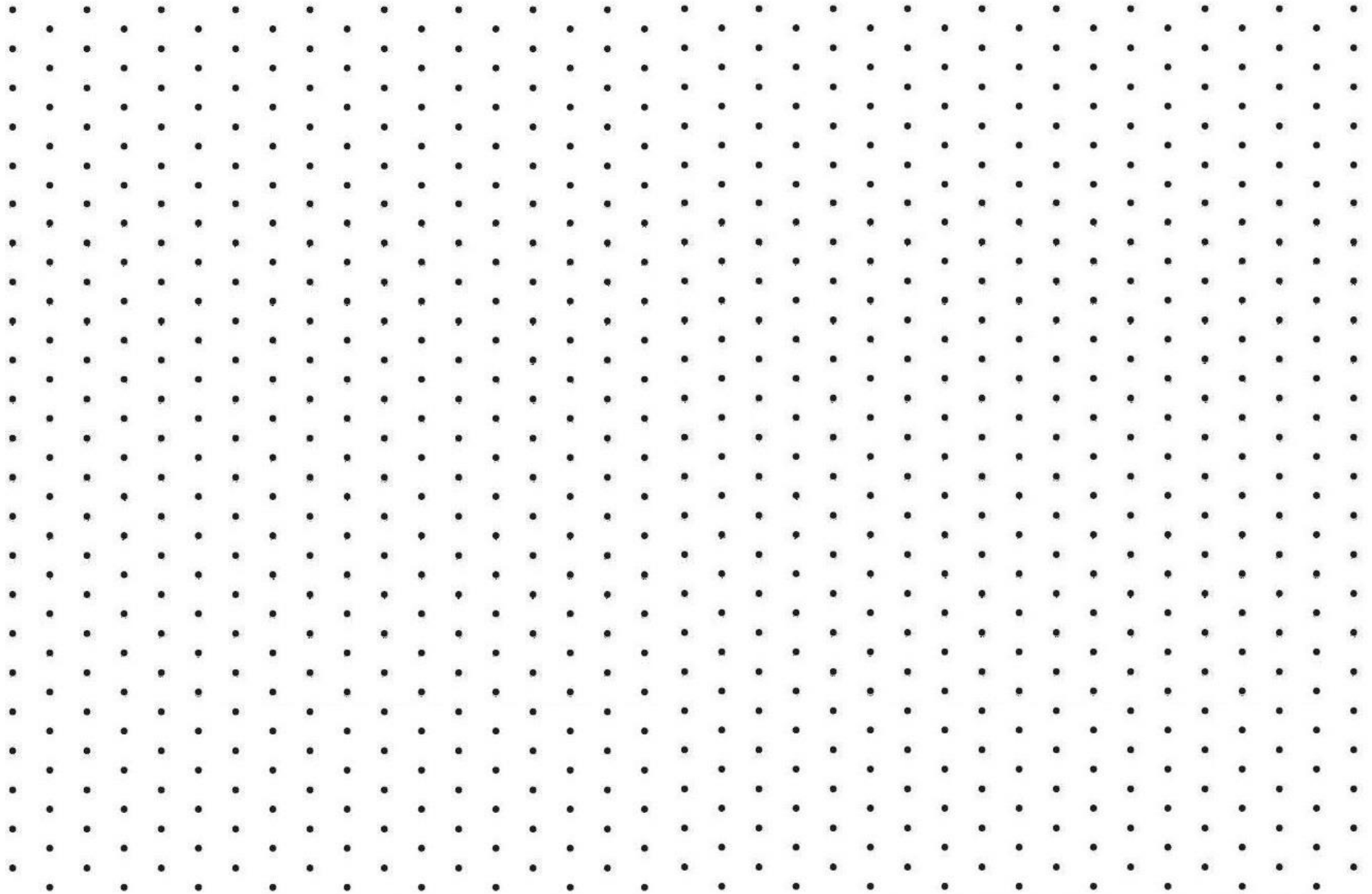



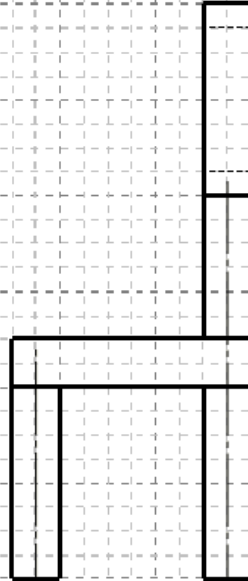
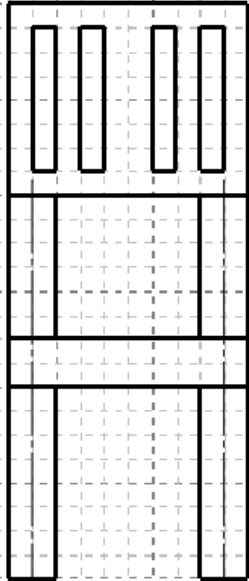
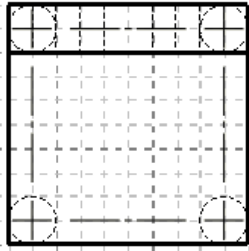

**Birdhouse: Draw the Isometric View**

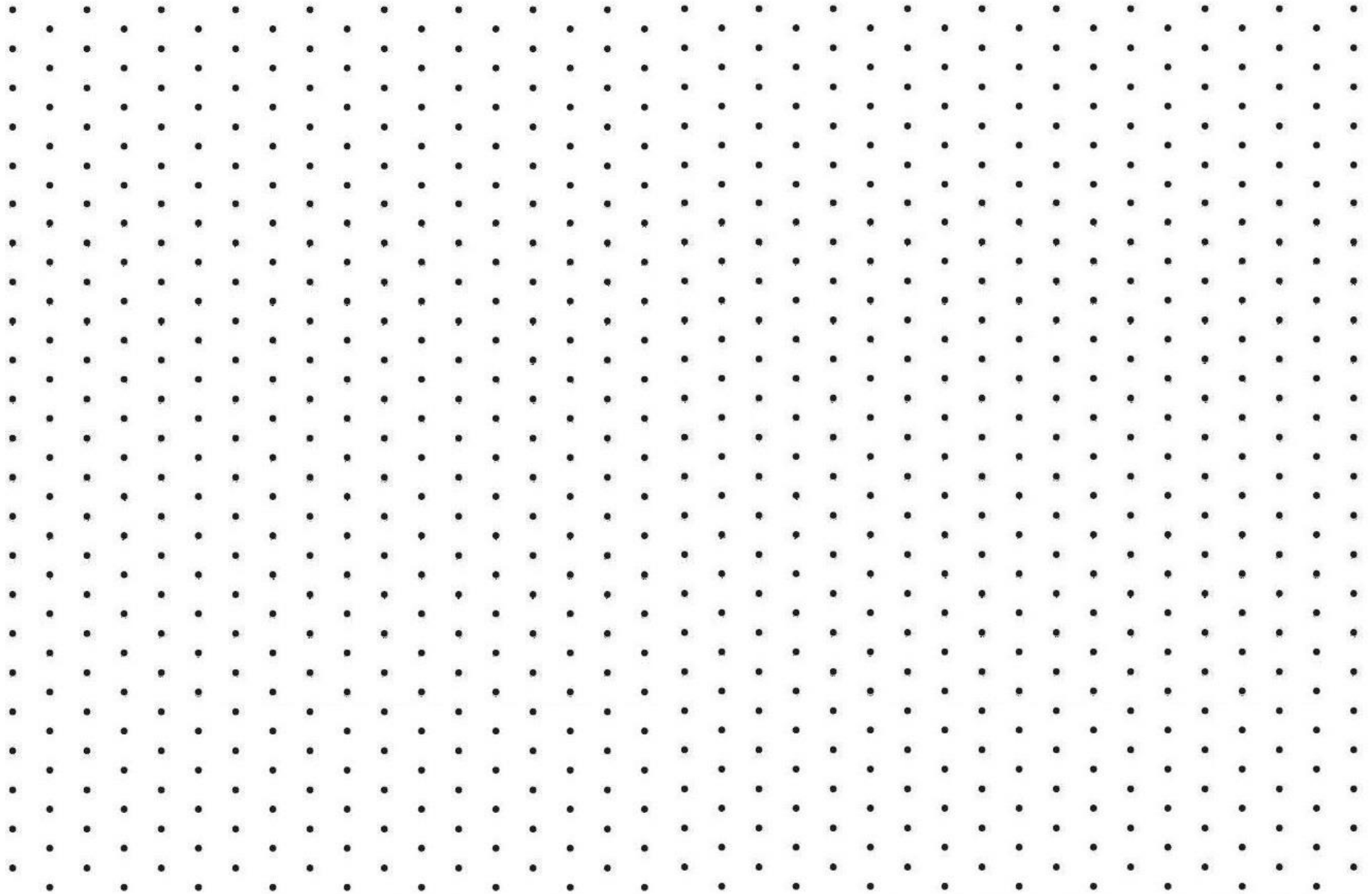

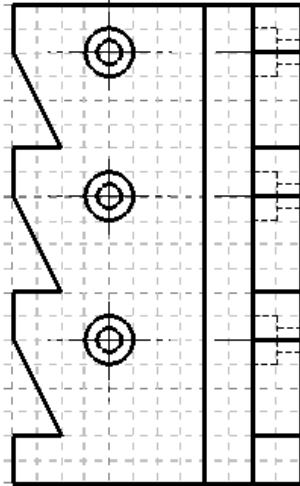
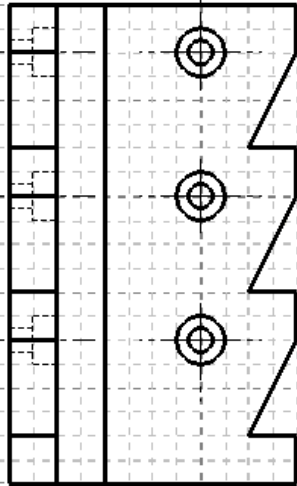
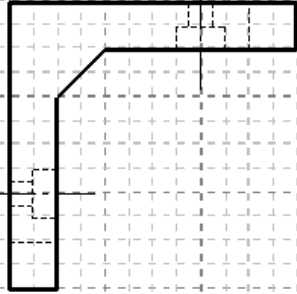

Complex: Draw the Isometric View

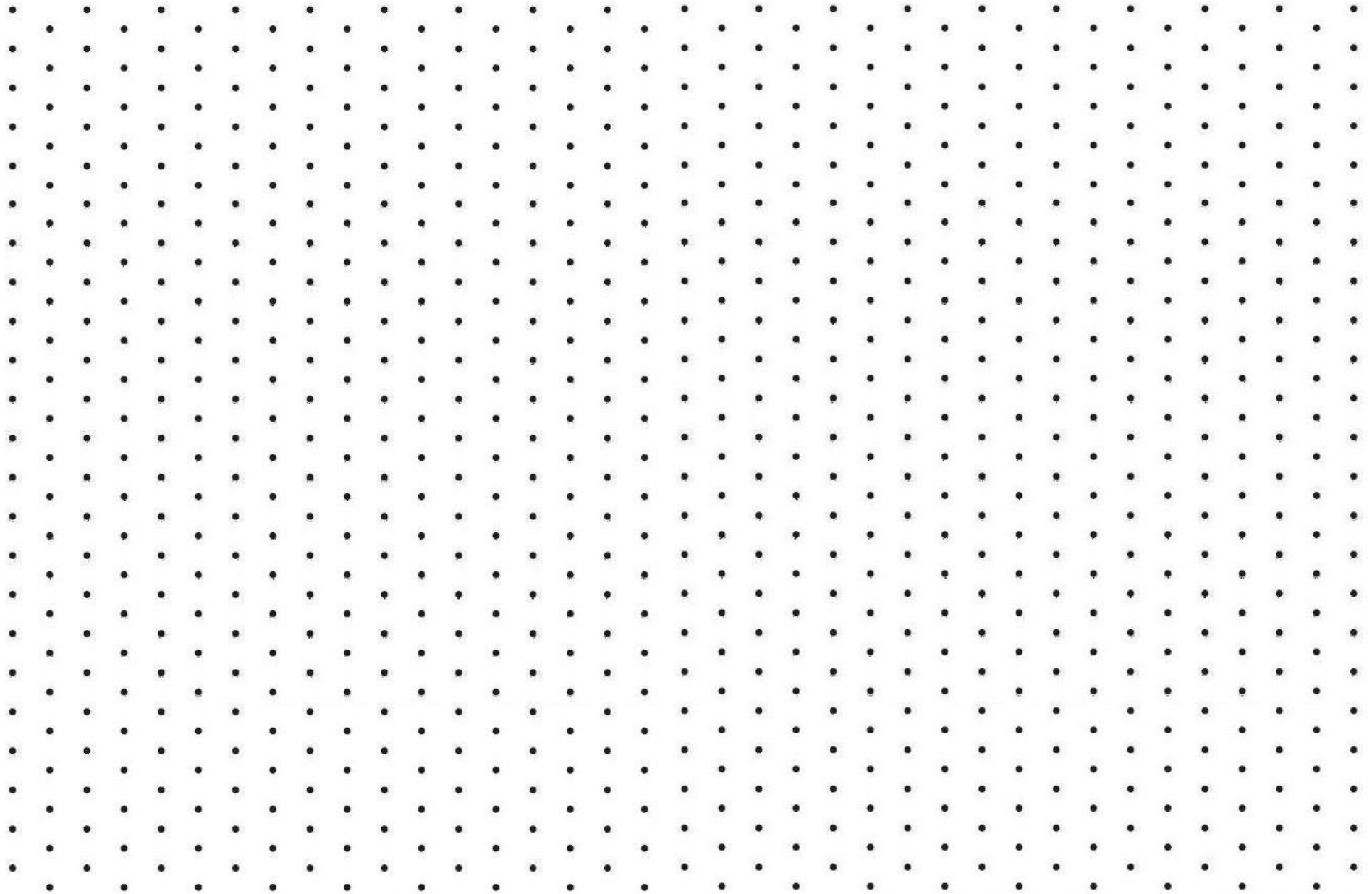

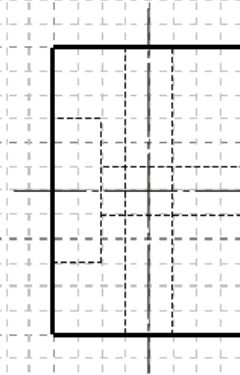
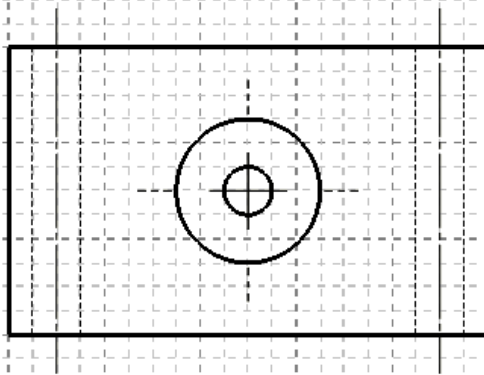
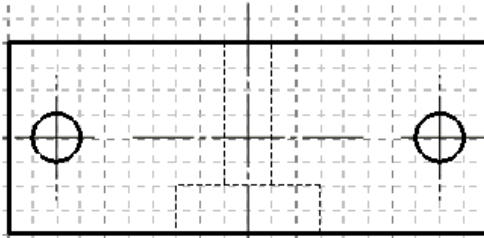

**Connecting Block: Draw the Isometric View**

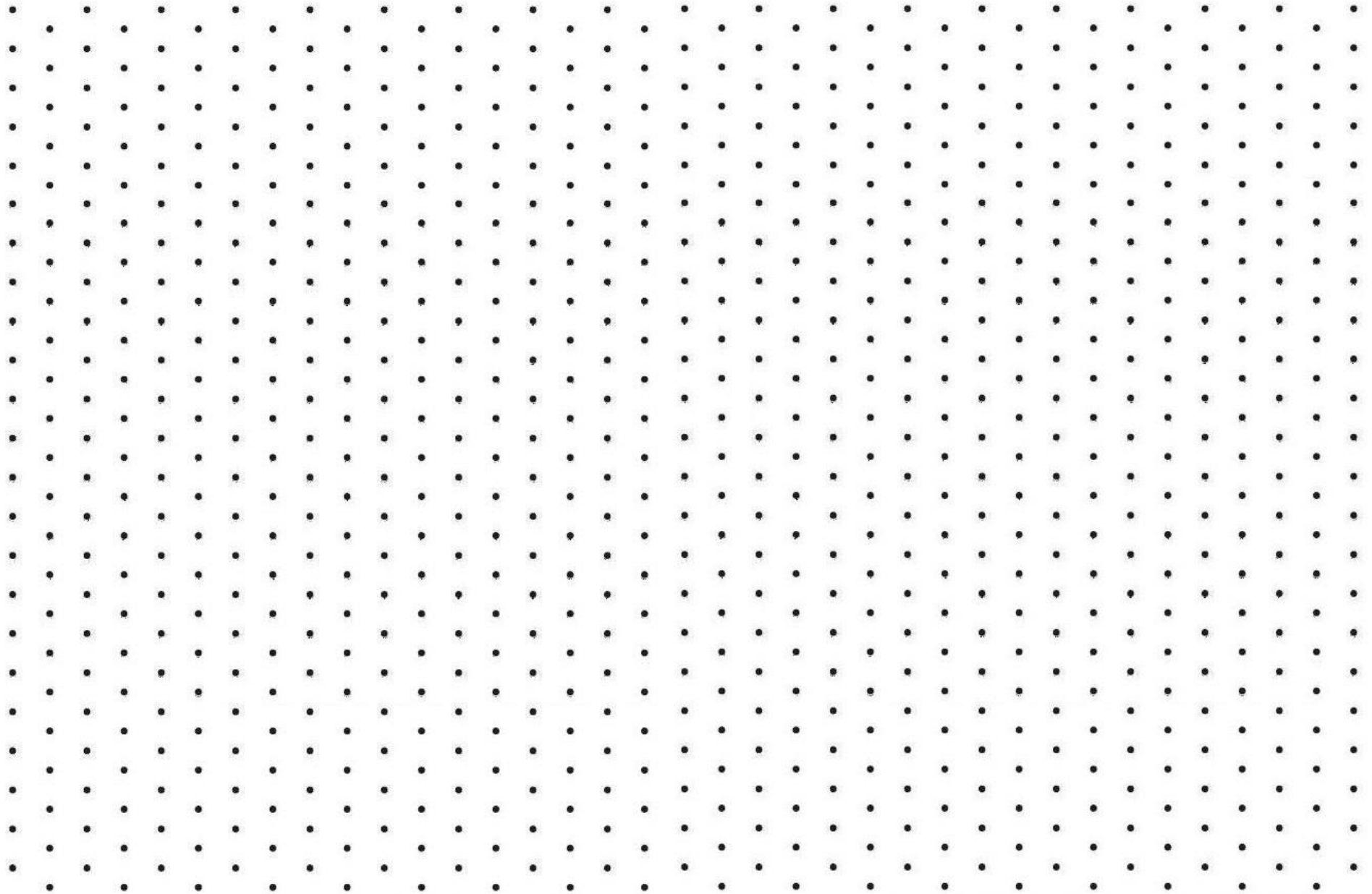

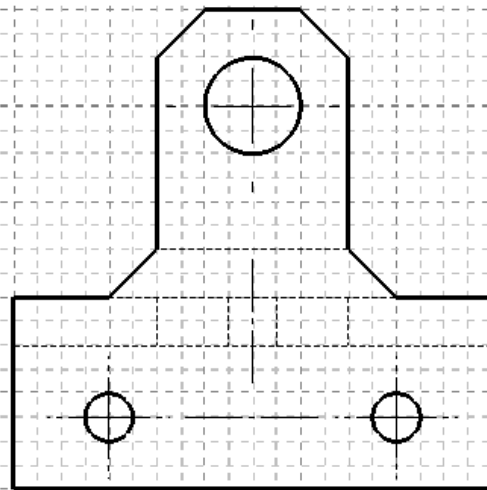
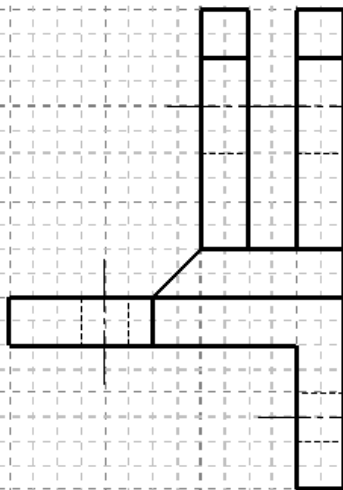
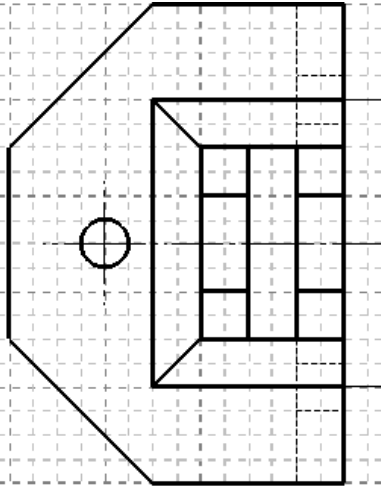

Five Hole Bracket: Draw the Isometric View

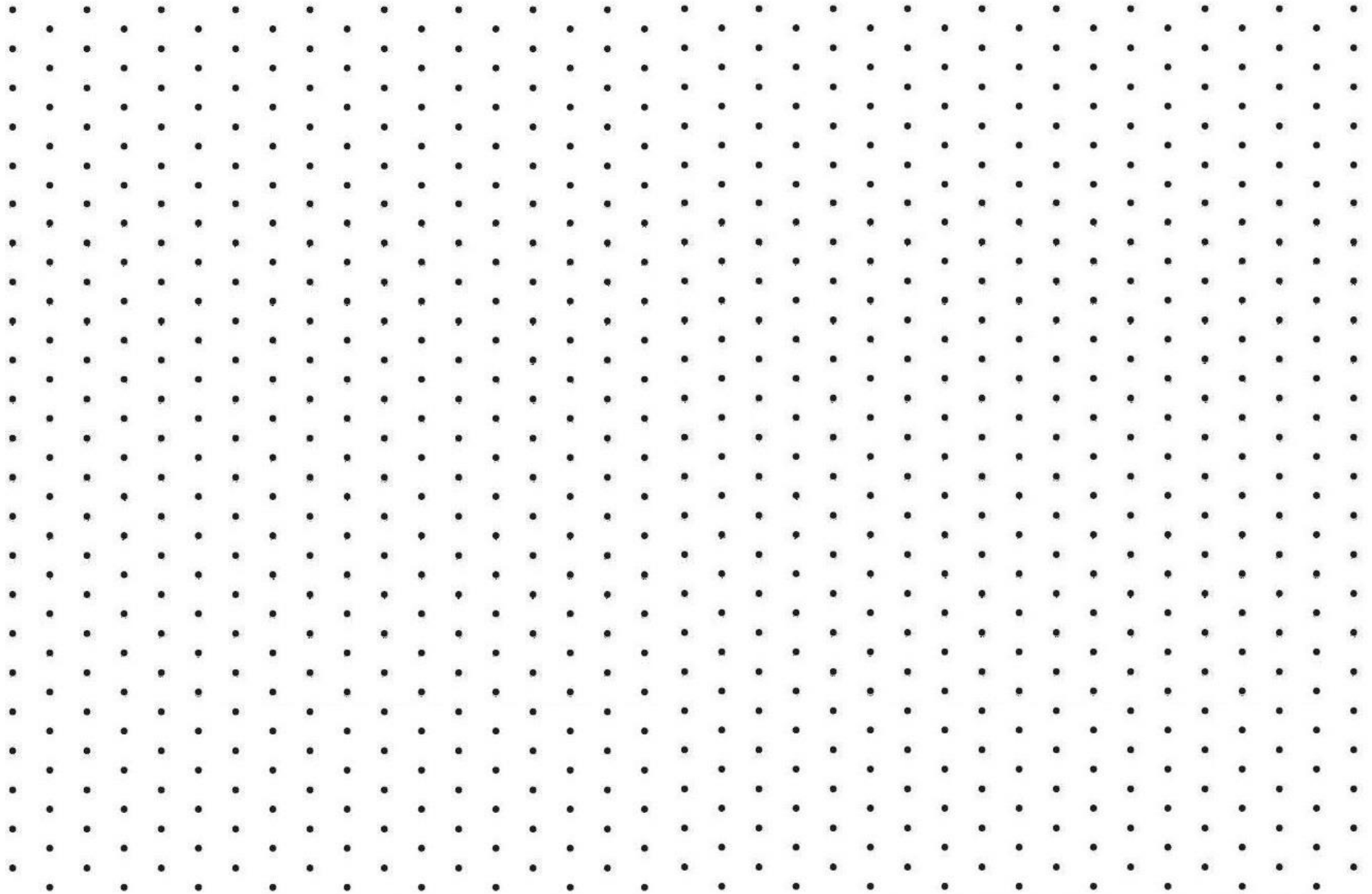



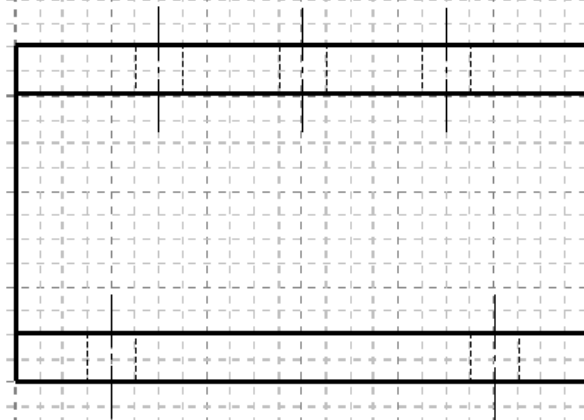
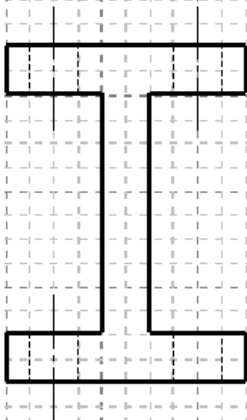
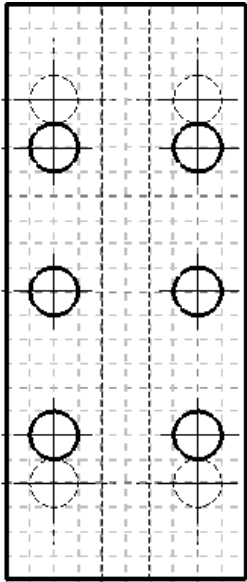

I Beam with Holes: Draw the Isometric View

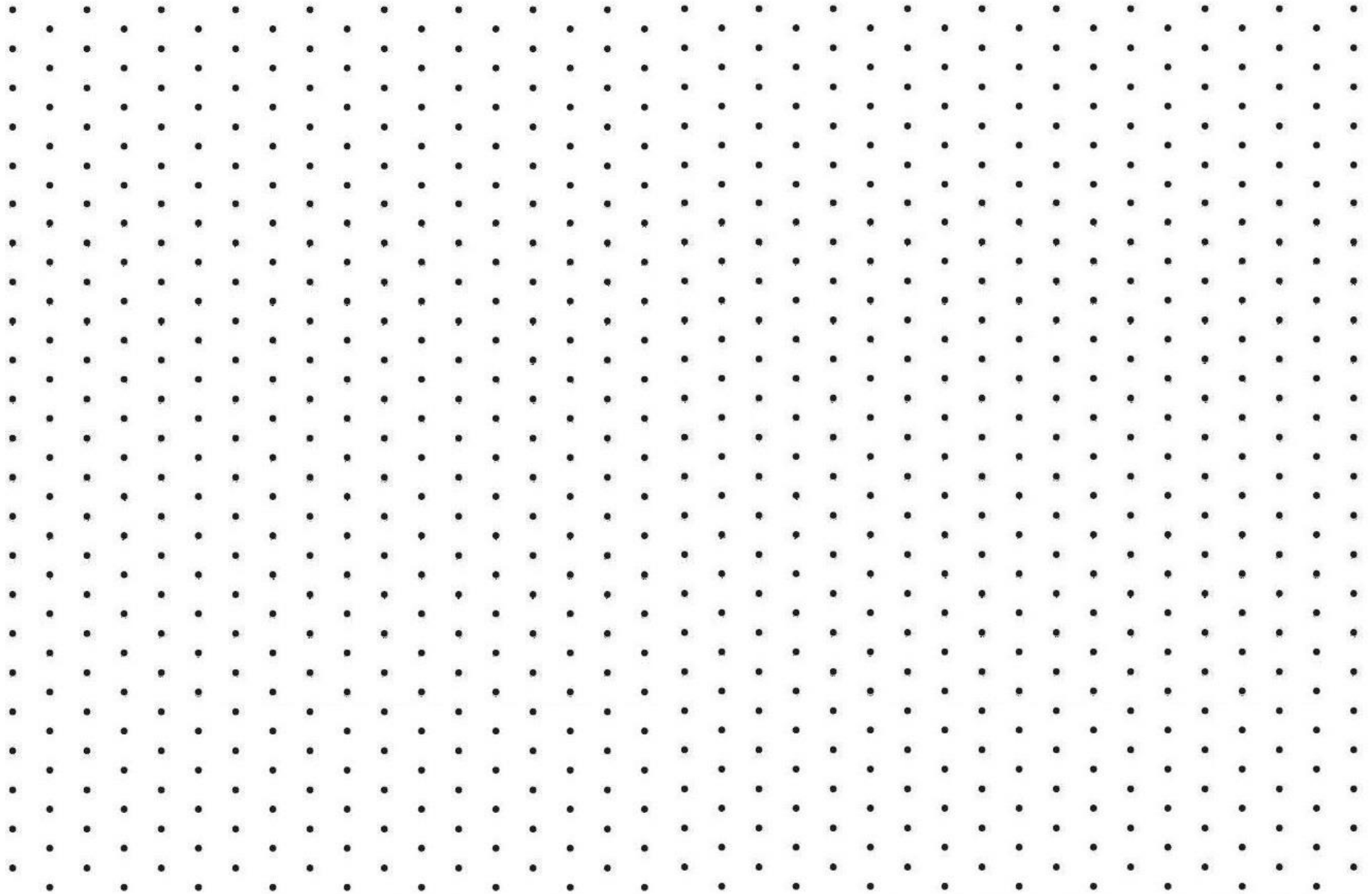

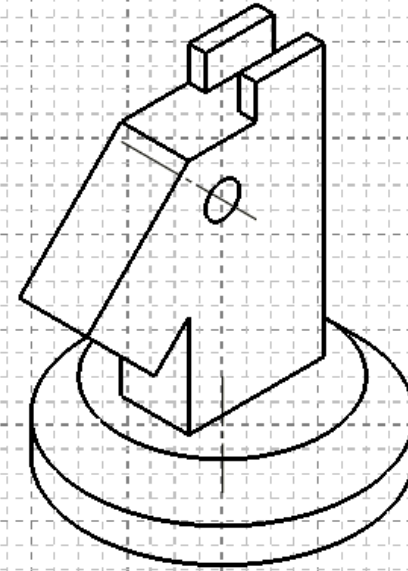
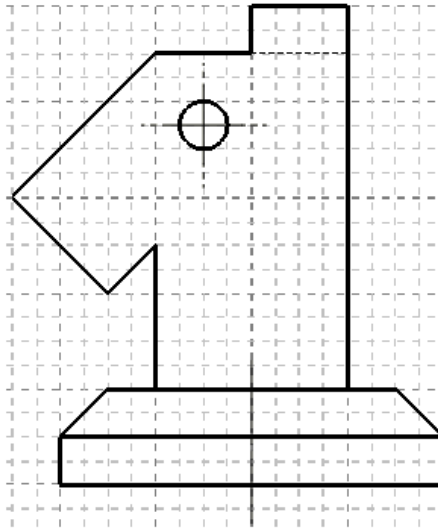
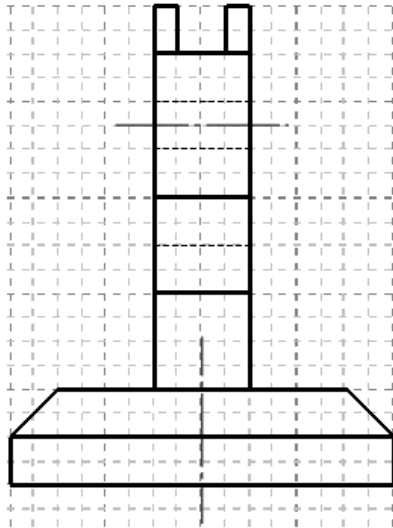
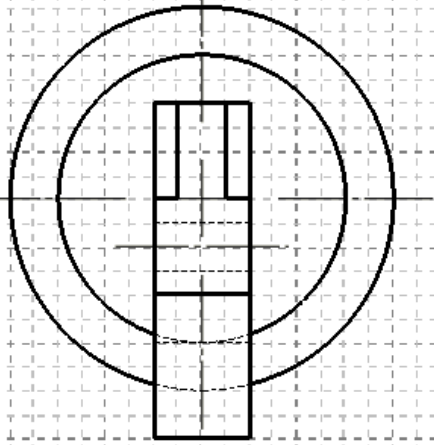

**Knight: Draw the Isometric View**

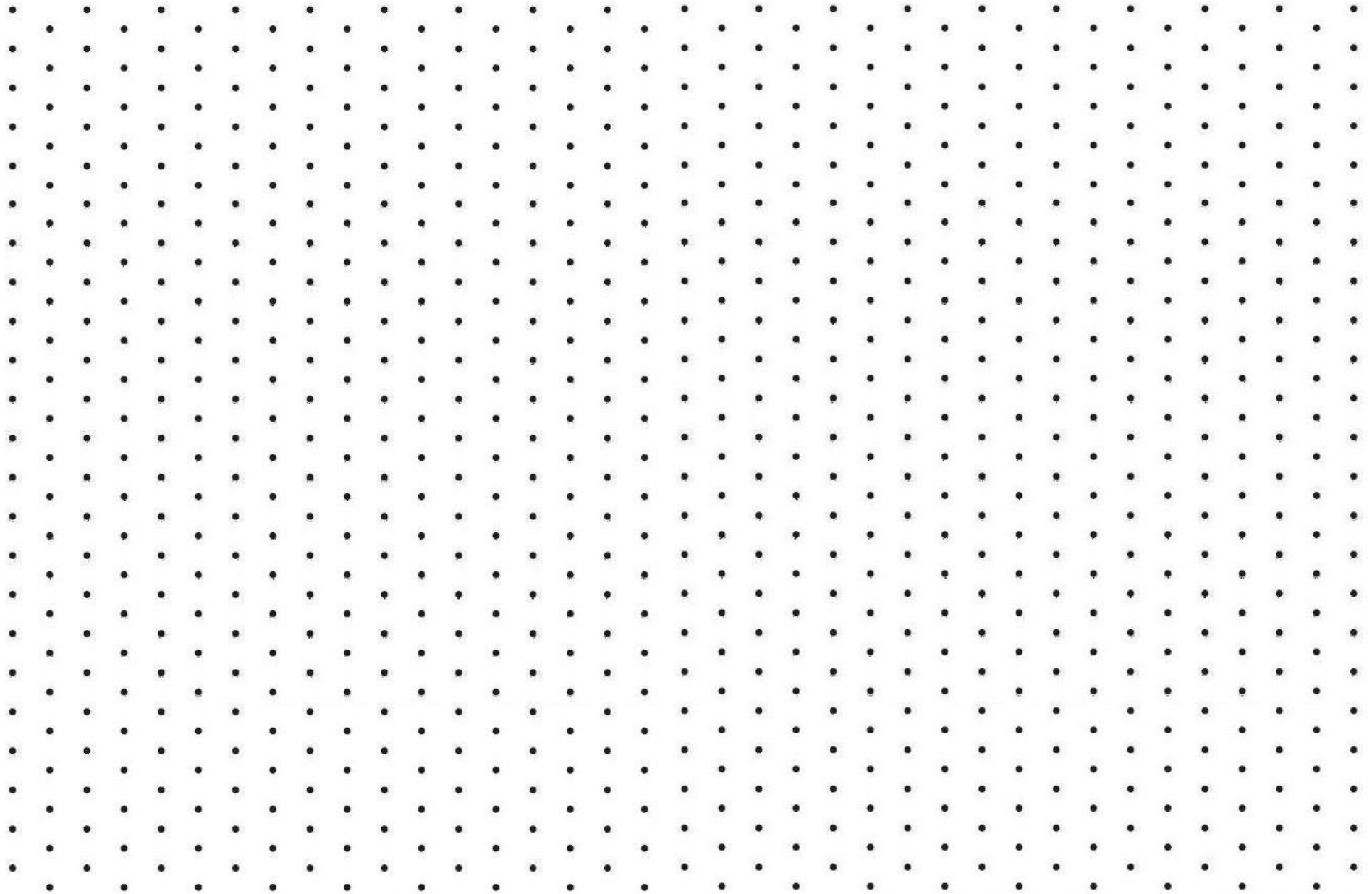

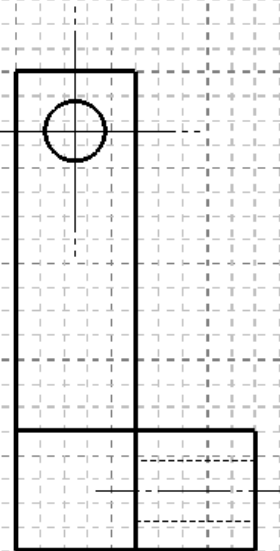
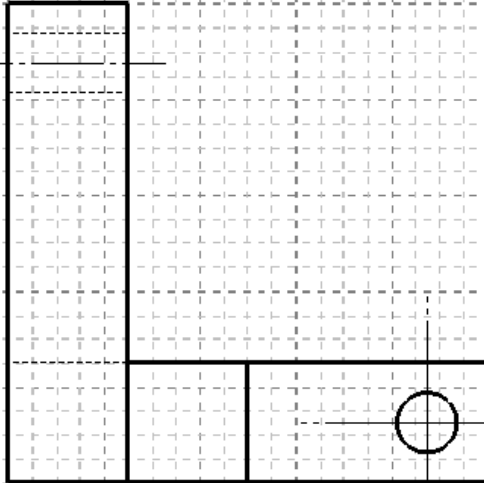
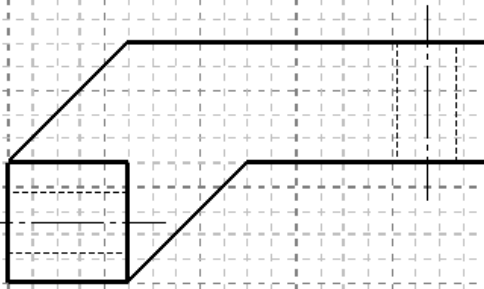

**L Bracket: Draw the Isometric View**

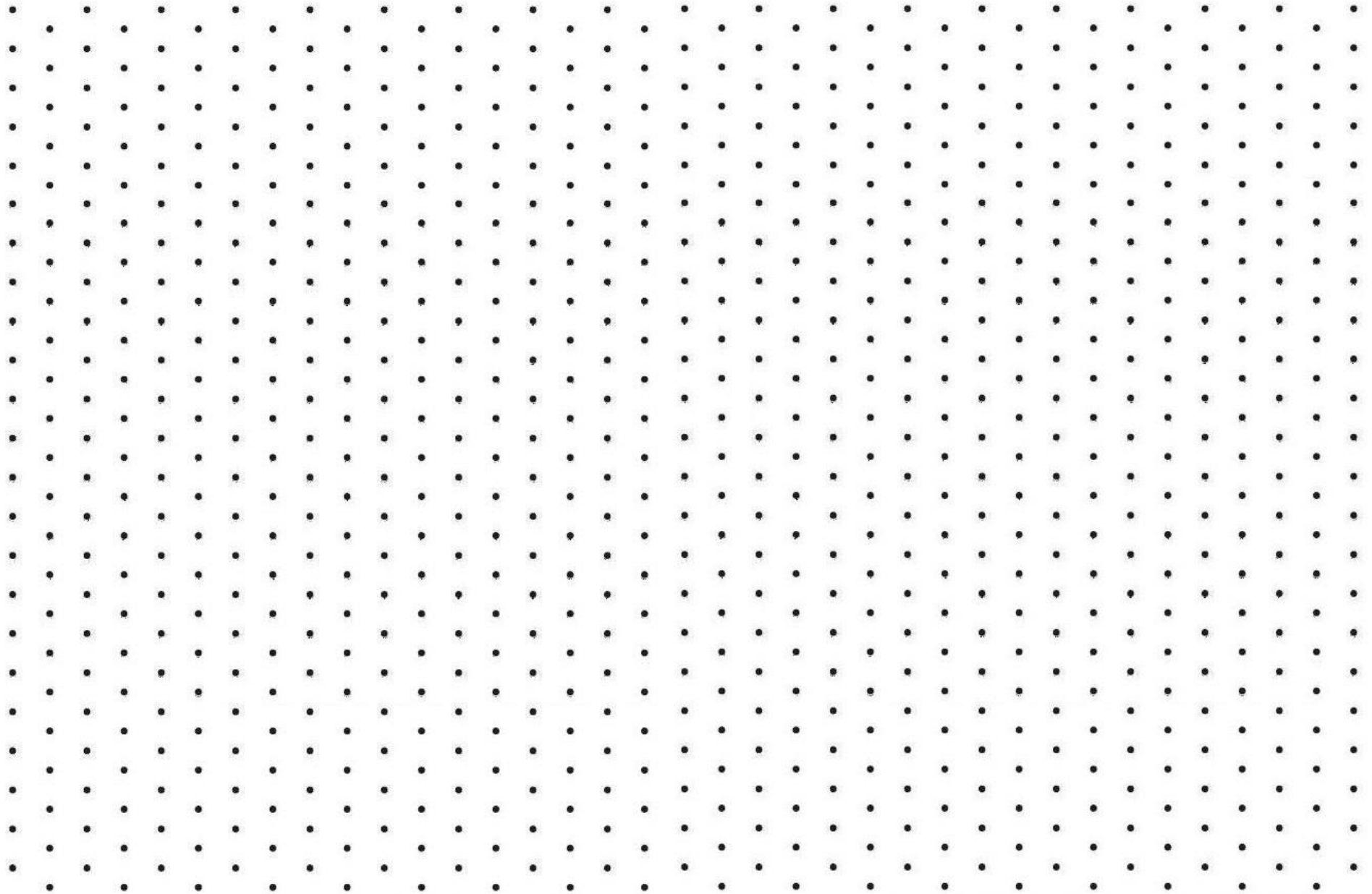

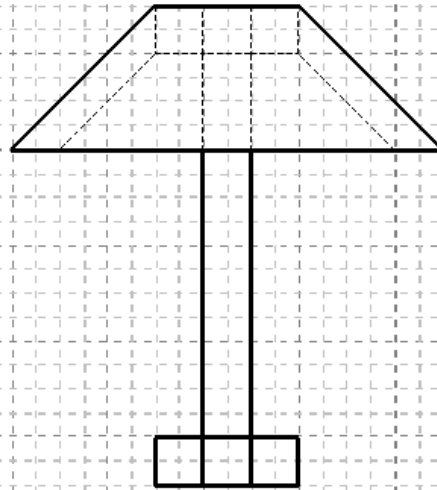
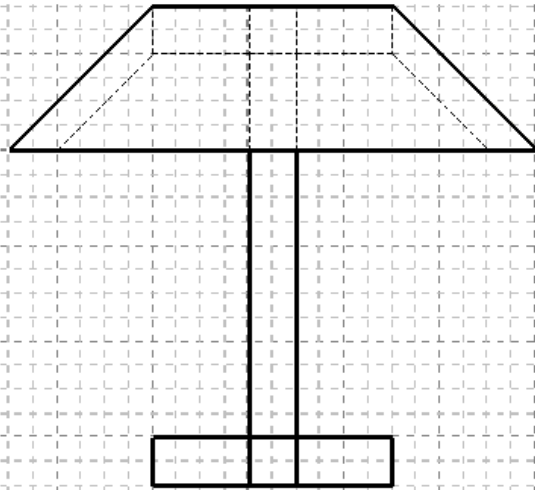
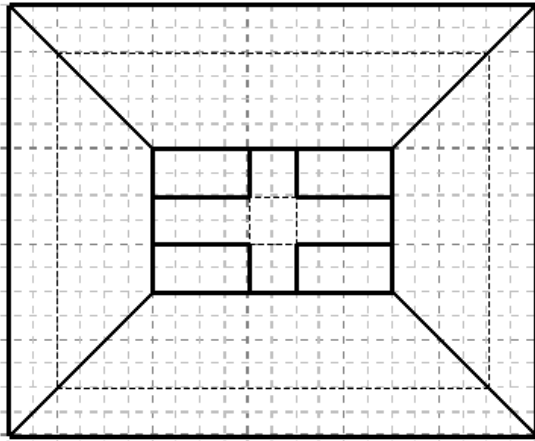

**Lamp: Draw the Isometric View**

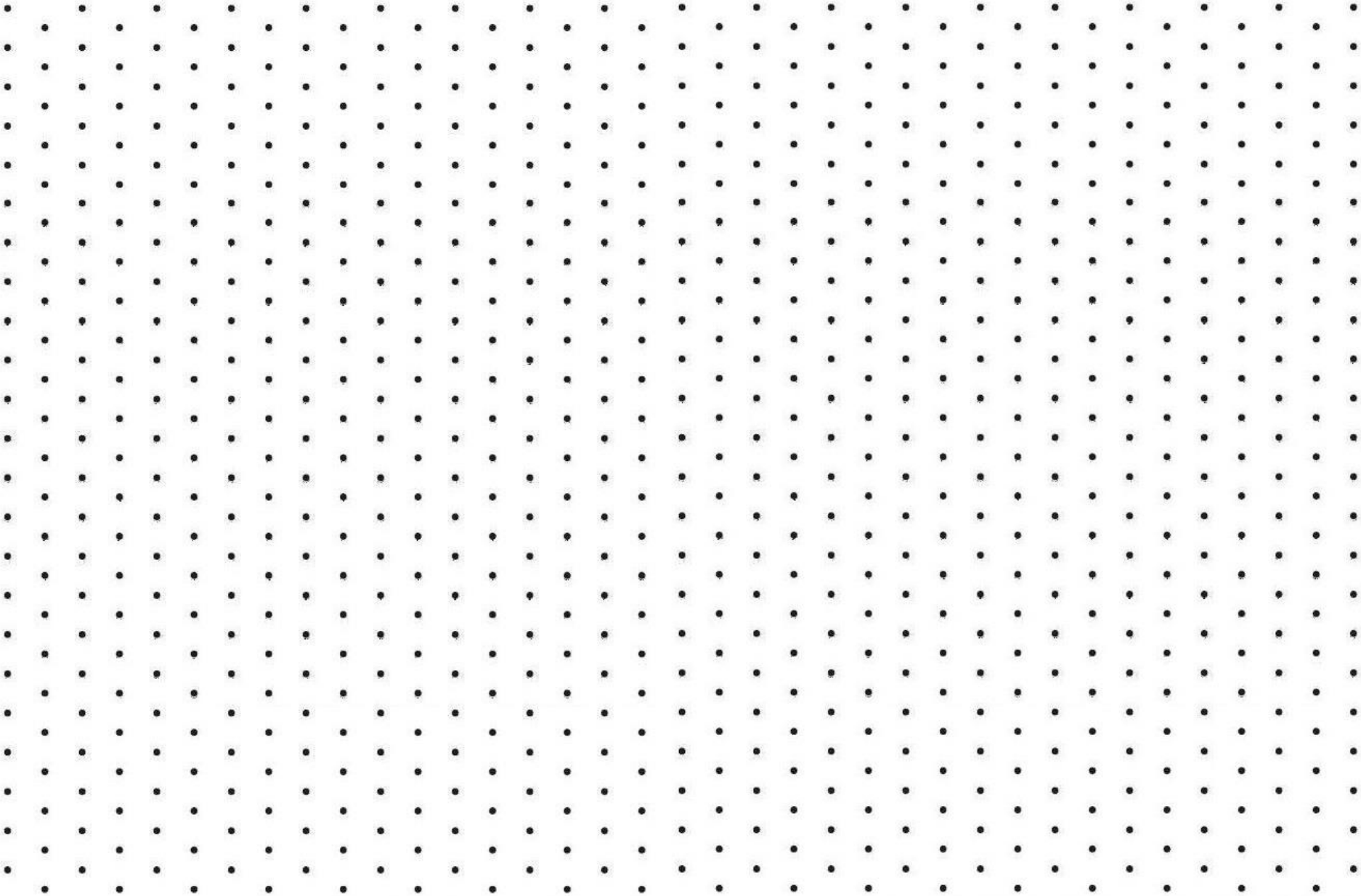



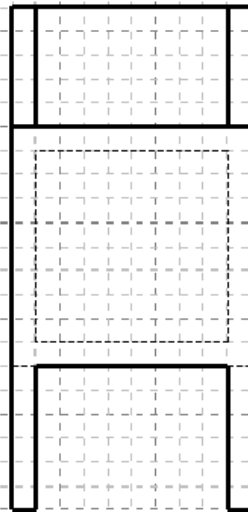
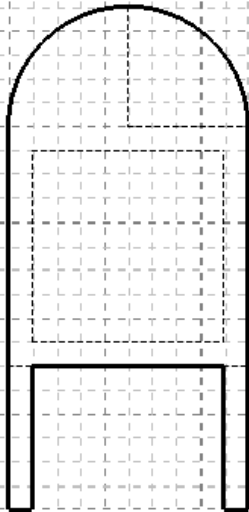
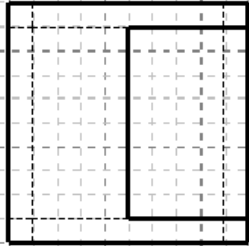

**Mailbox: Draw the Isometric View**

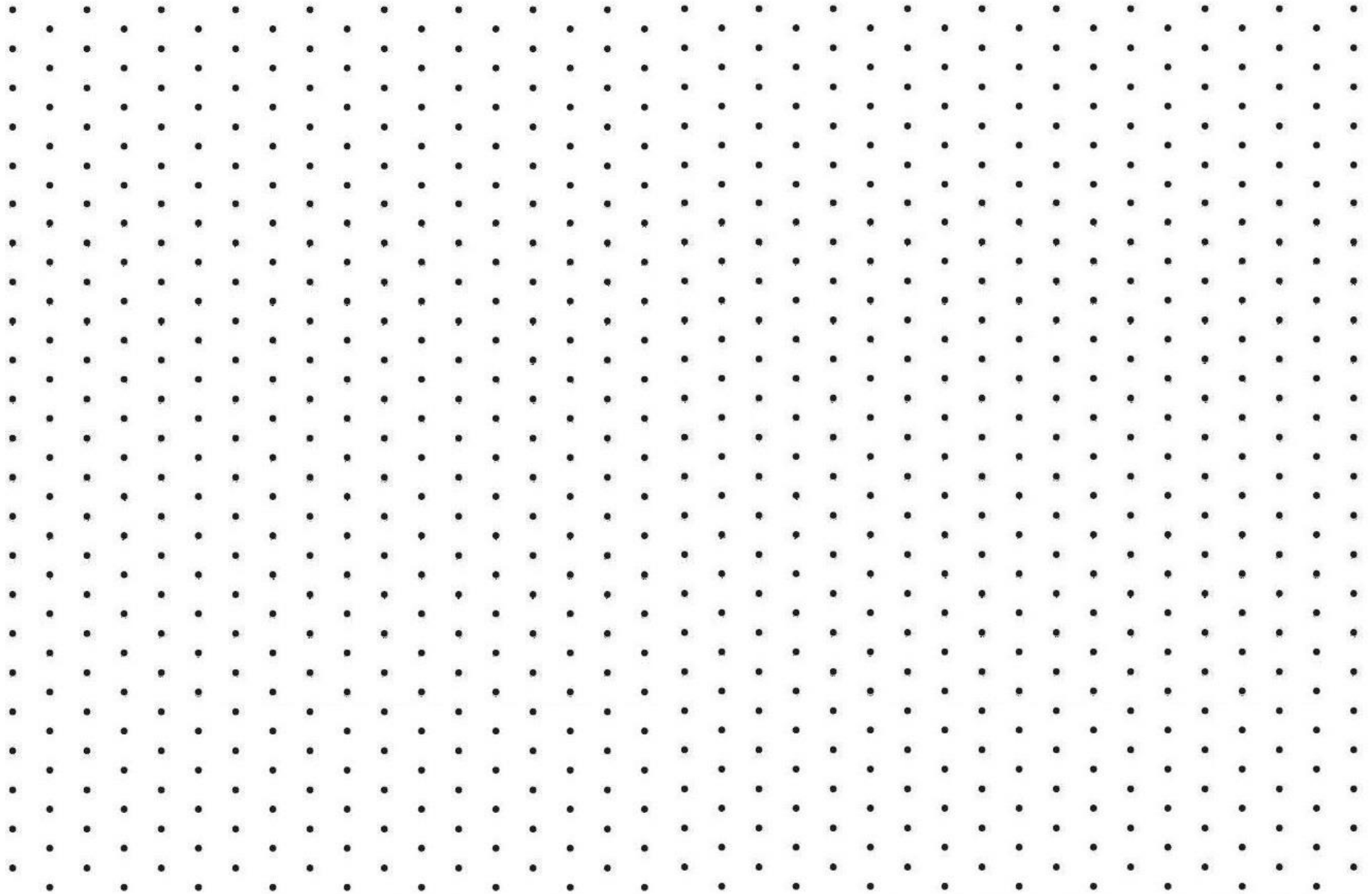

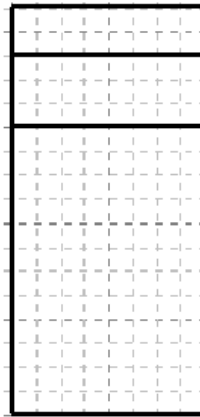
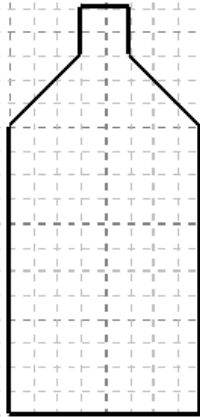
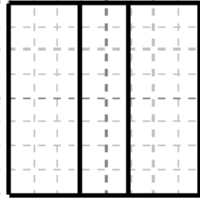

**Milk Carton: Draw the Isometric View**

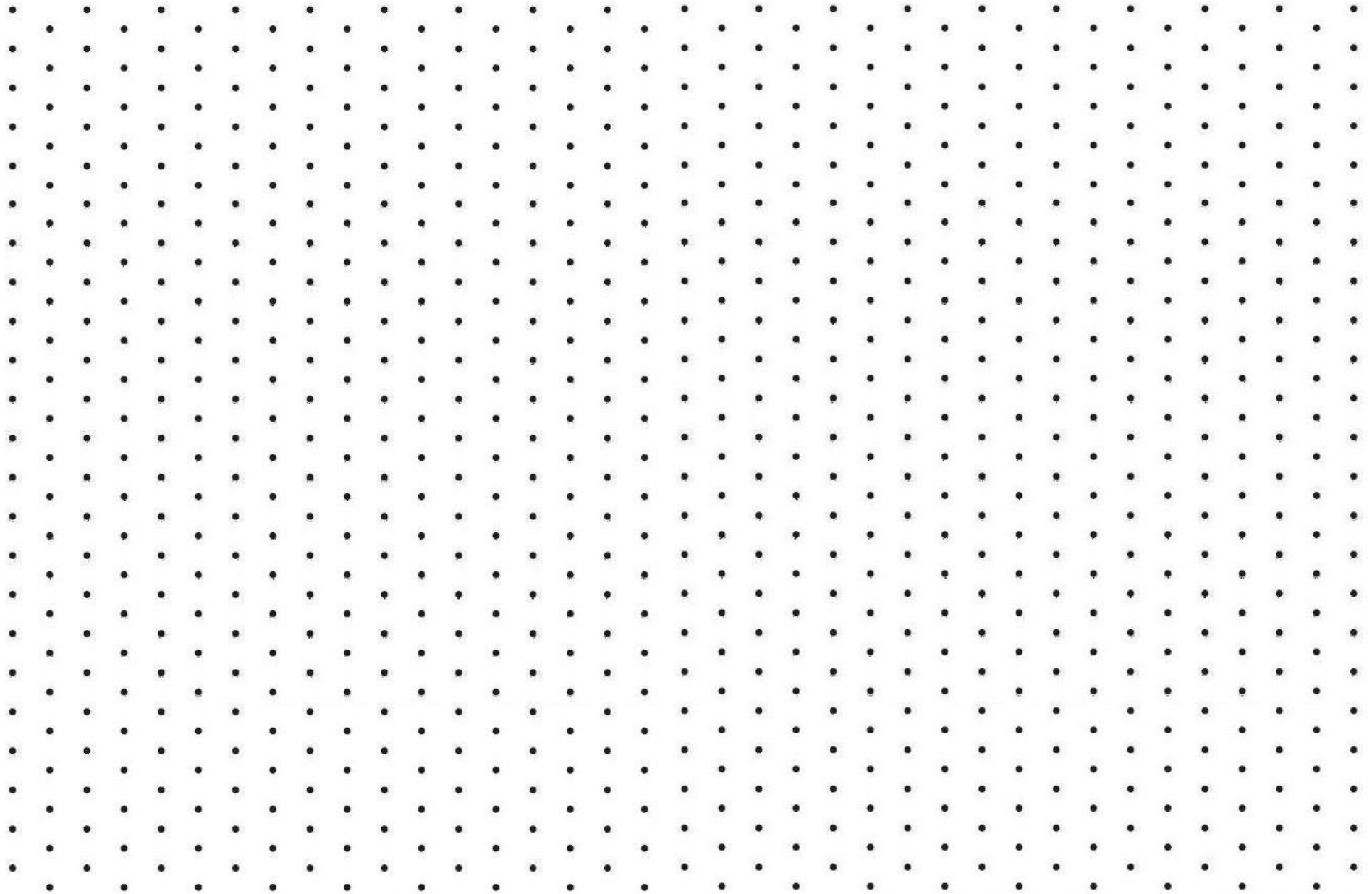

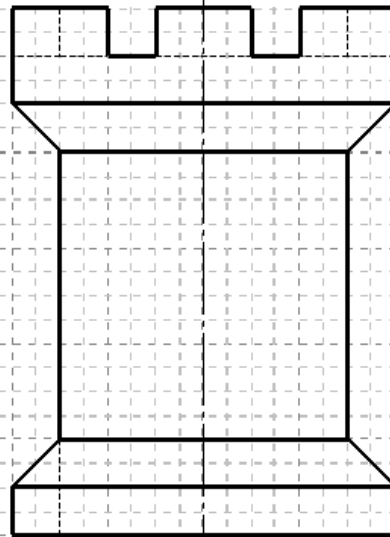
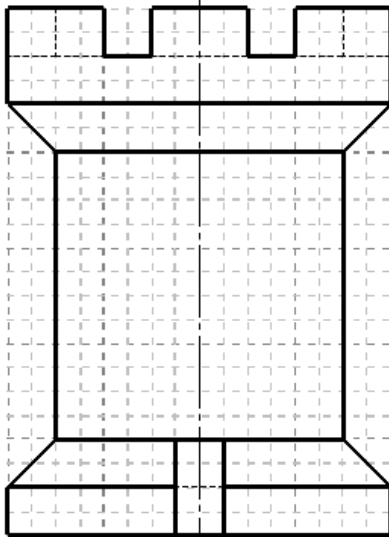
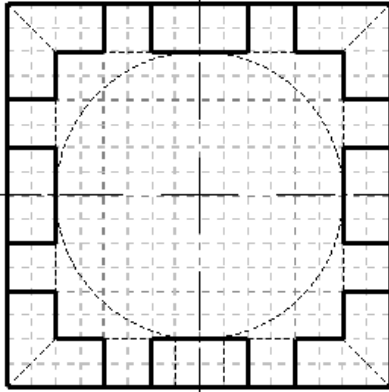

Rook: Draw the Isometric View

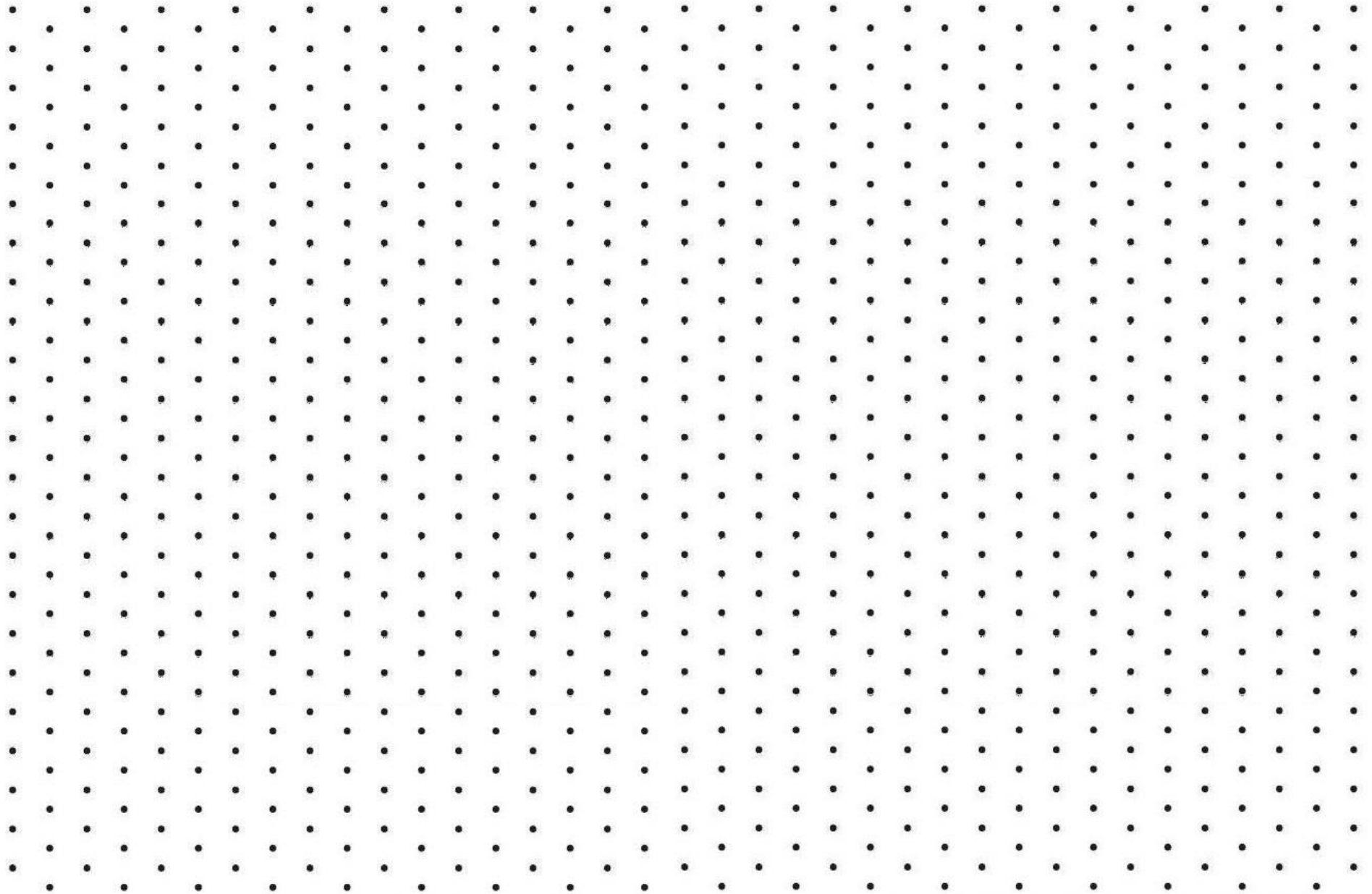

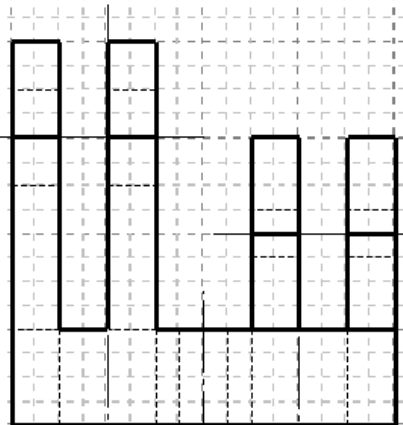
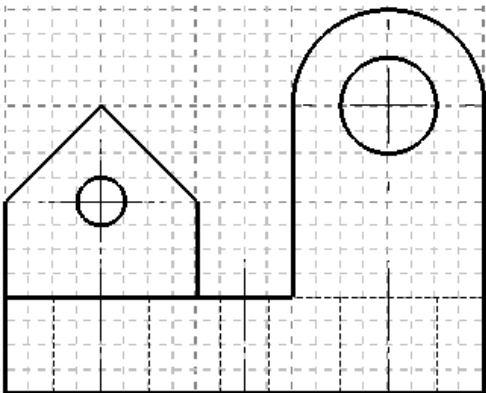
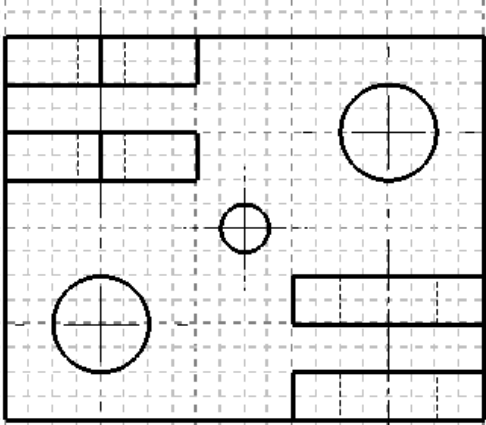

Seven Hole Stand: Draw the Isometric View

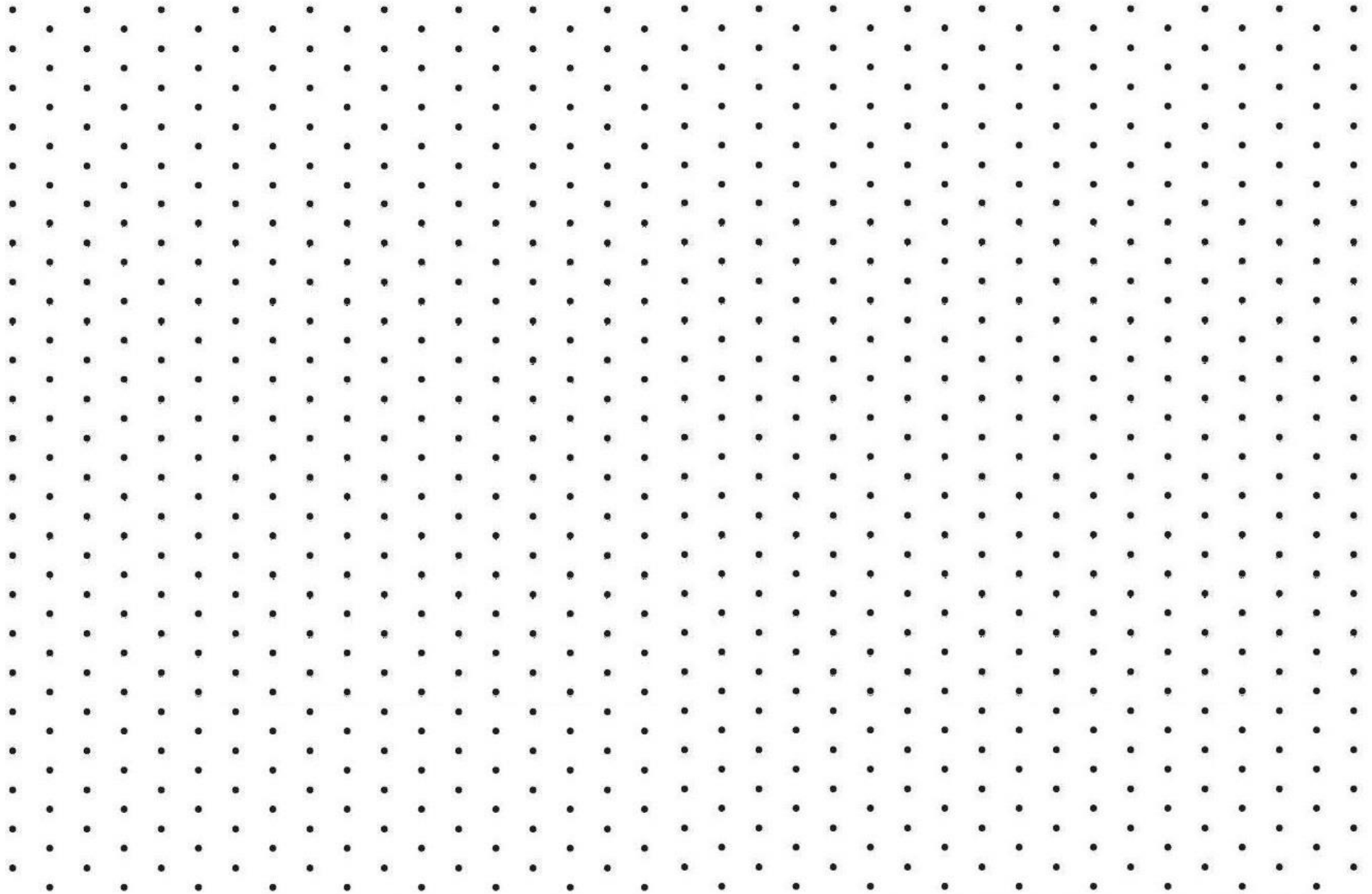



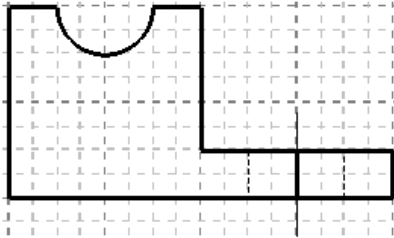
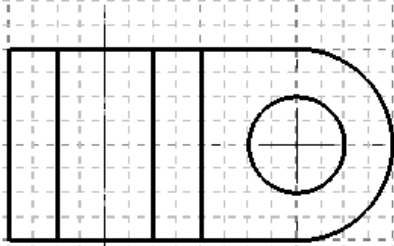

**Shaft Support: Draw the Isometric View**

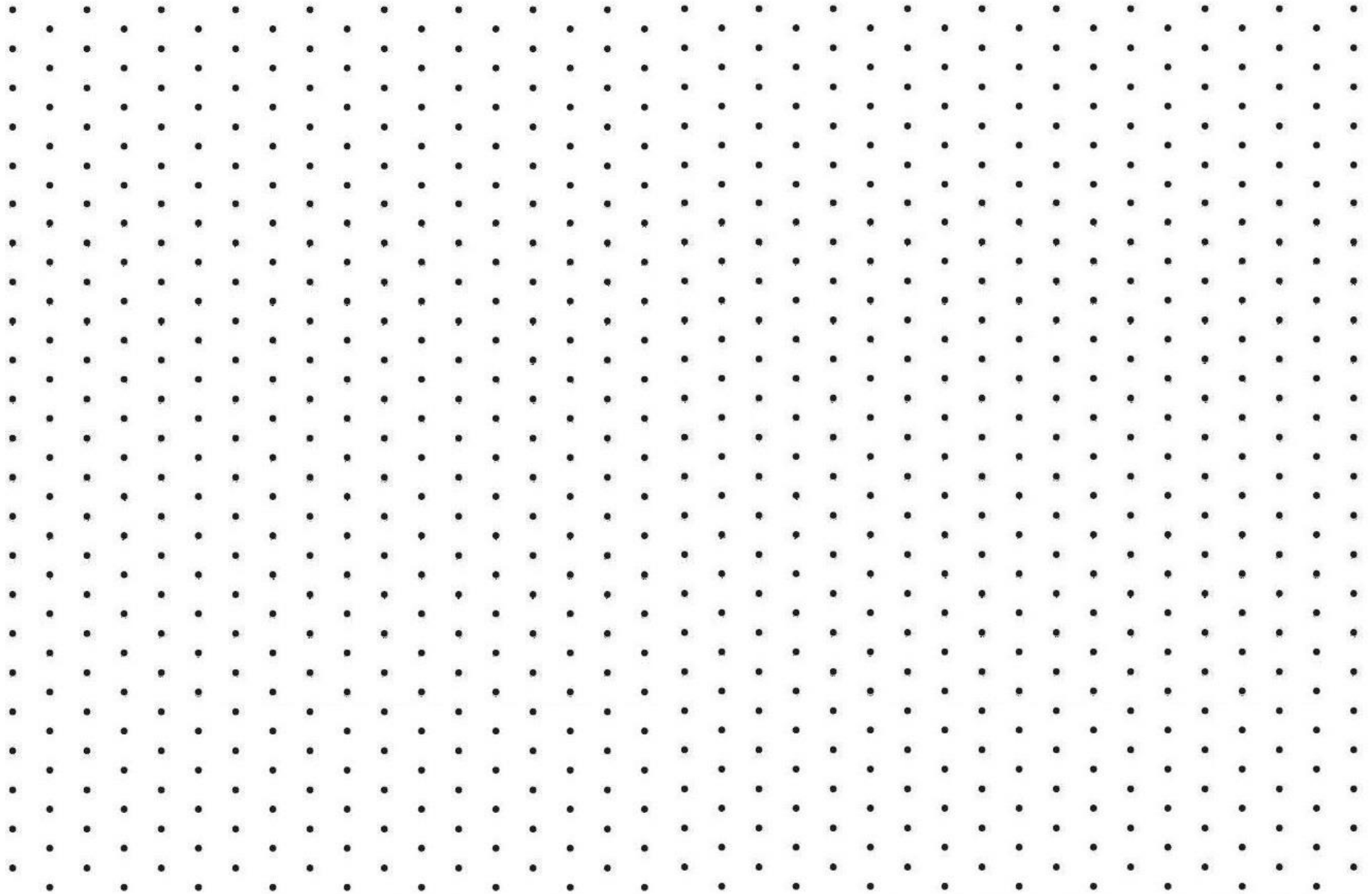

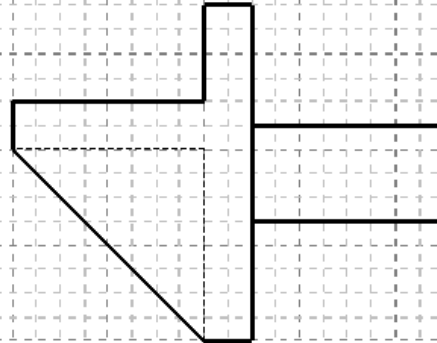
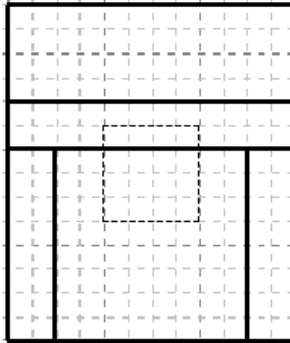
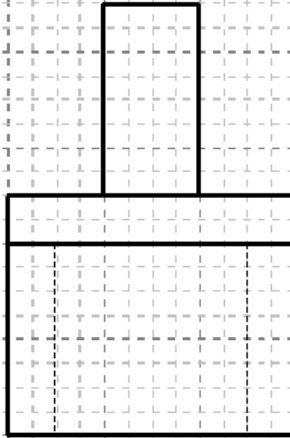

**Shelf Support: Draw the Isometric View**

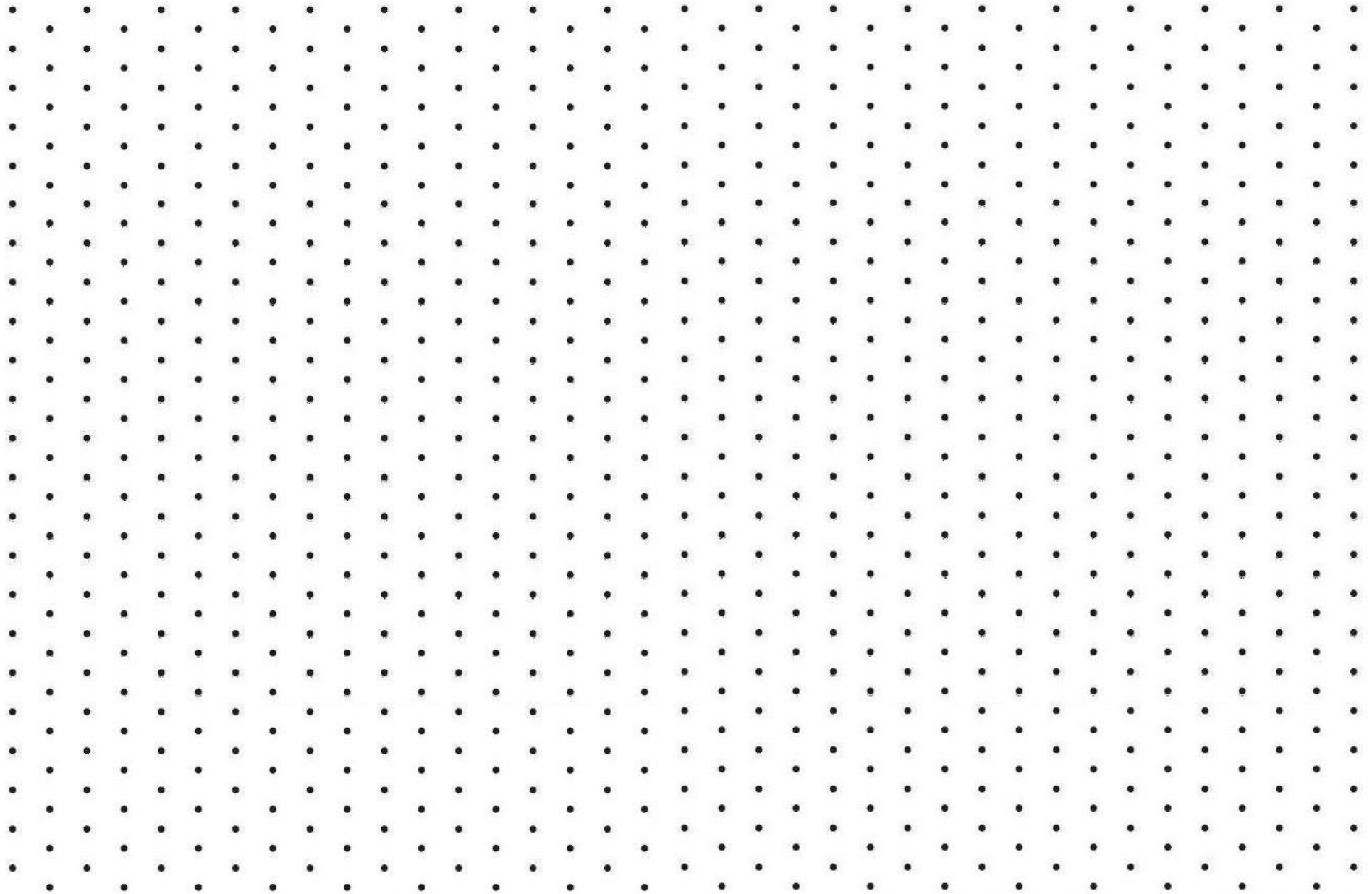

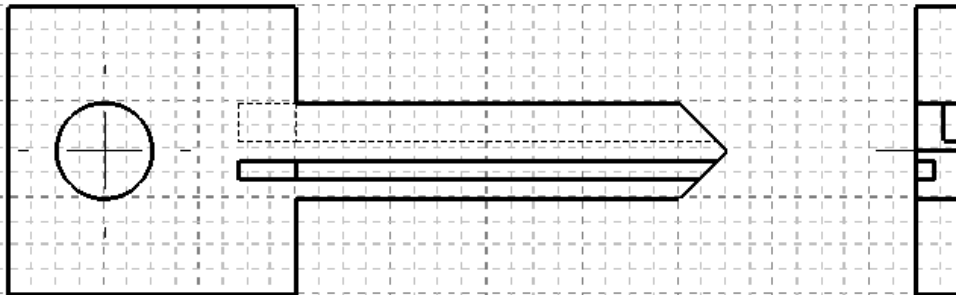
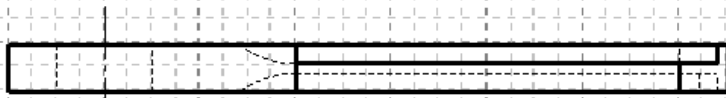

Uncut Key: Draw the Isometric View

